

Ushtrimi 1 : Kompletoni figuren me projeksionin qe mungon.

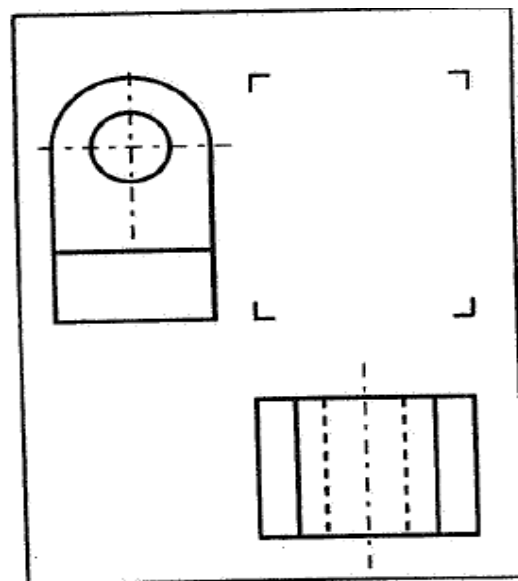

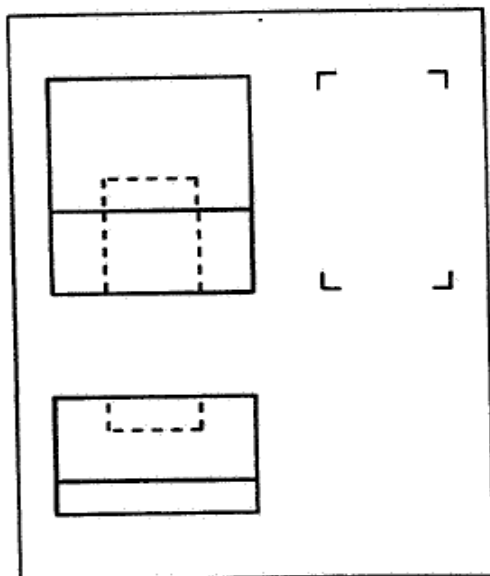

Ushtrimi 2 : Te realizohen pamjet sipas rregullave te projektimit orthogonal te figures se dhene ne aksonometri.

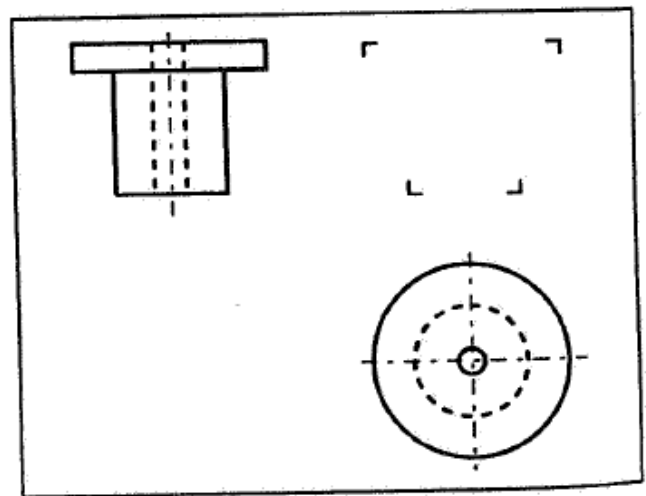
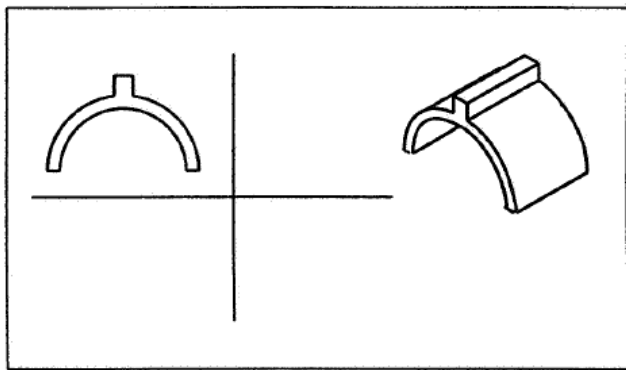
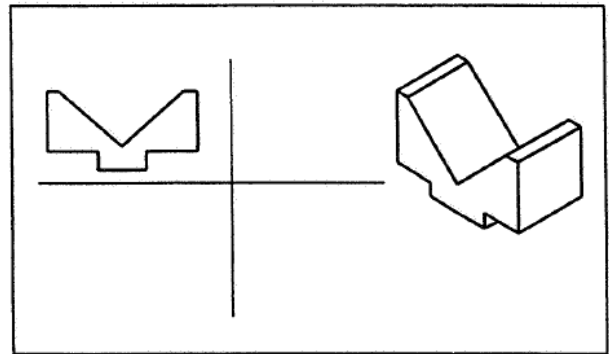
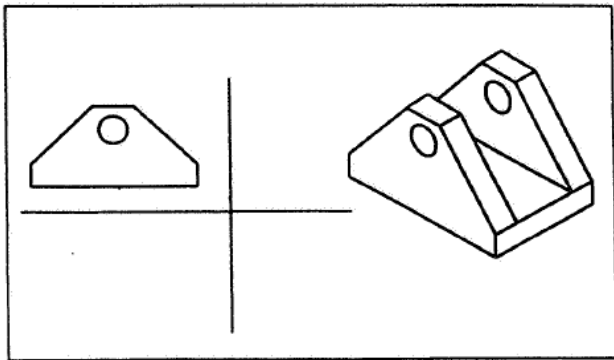
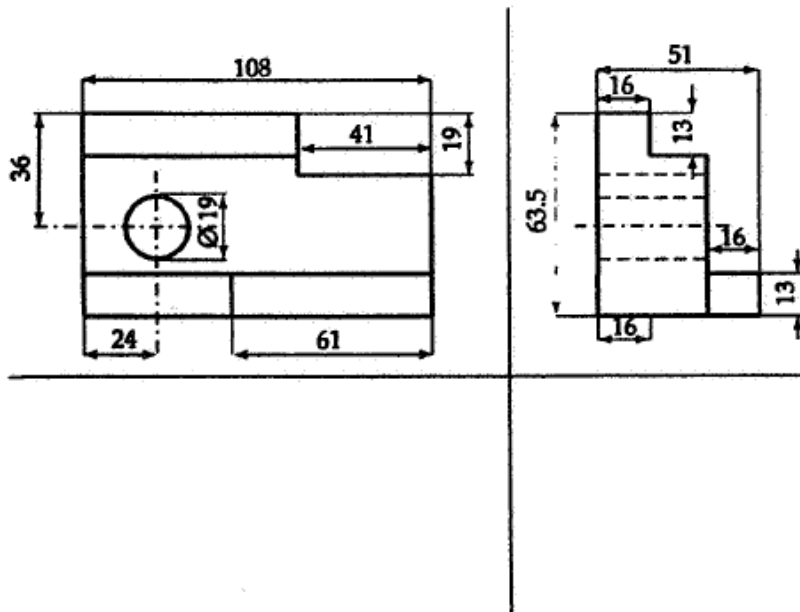