

TE NDERTOHEH PRERJA E NJE KONI ME ZGAVER I CILI E KA BAZEN NE PLANIN HORIZONTAL TE PROJEKTIMIT ME NJE PLAN NE POZICION TE PERGJITHSHEM

1

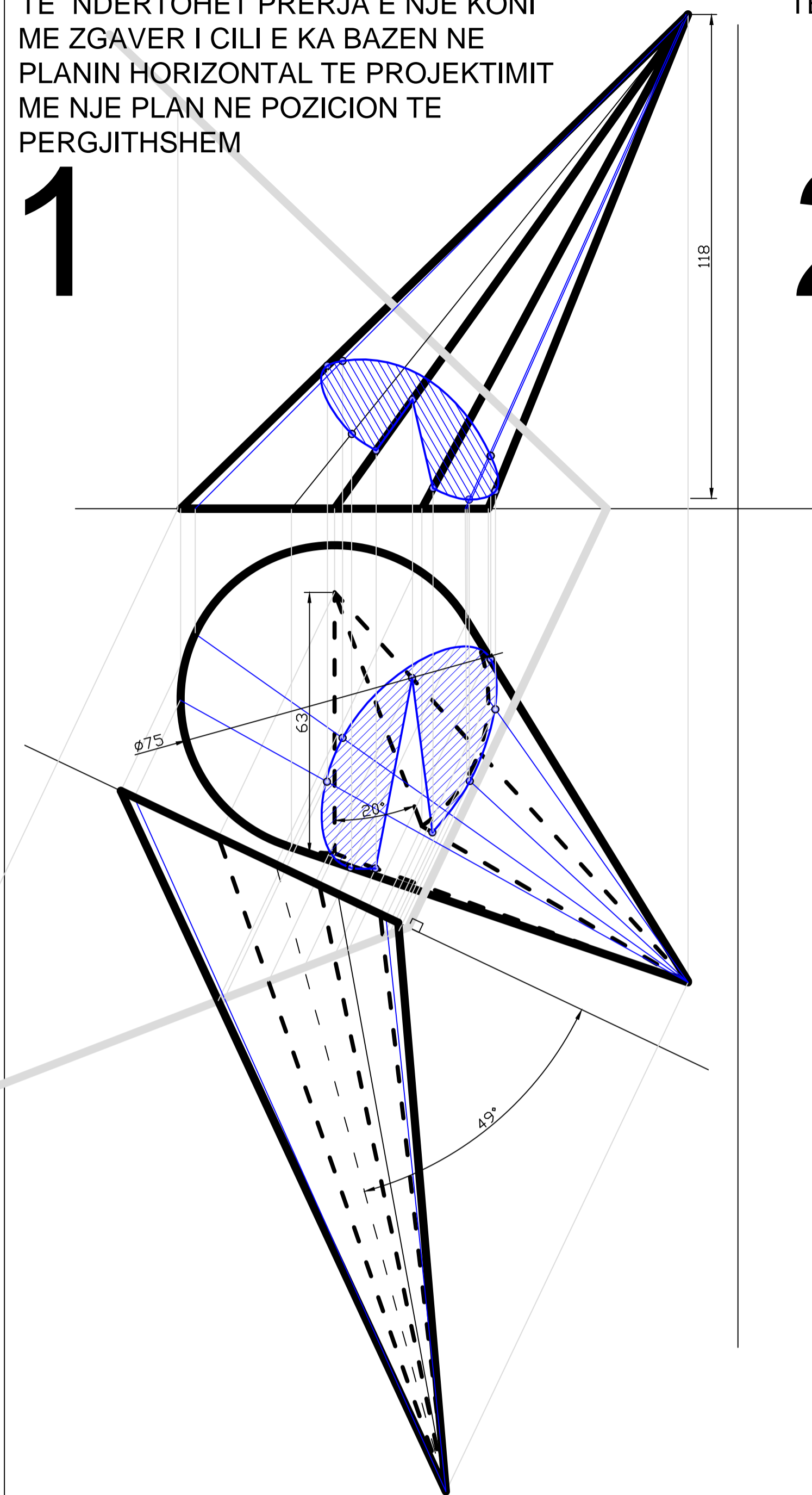

TE NDERTOHEH TRE PAMJET E TRUPIT

8

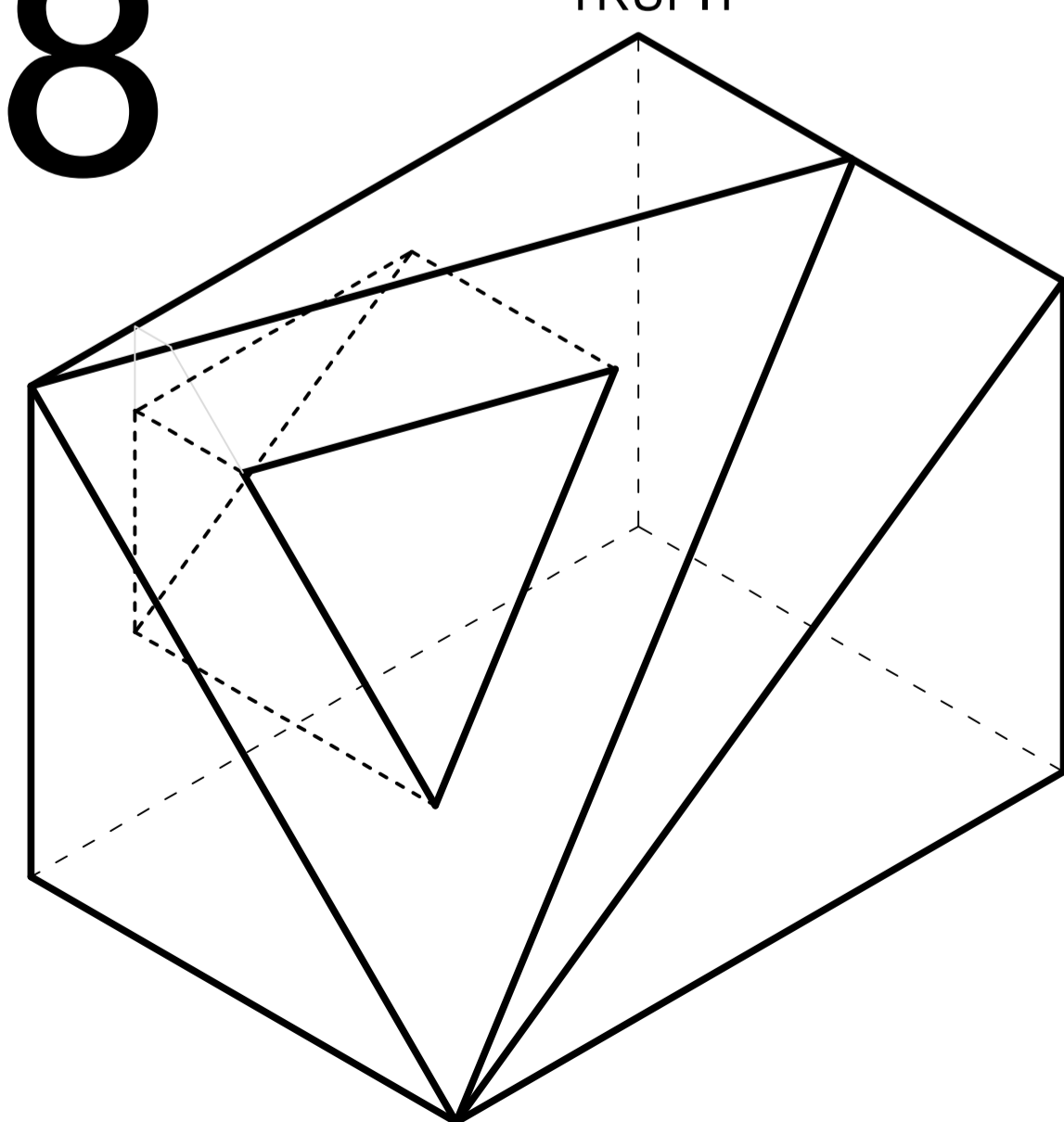

TE NDERTOHEH TRE PAMJET E TRUPIT SIPAS PERMASAVE TE DHENA NE FIGURE

2

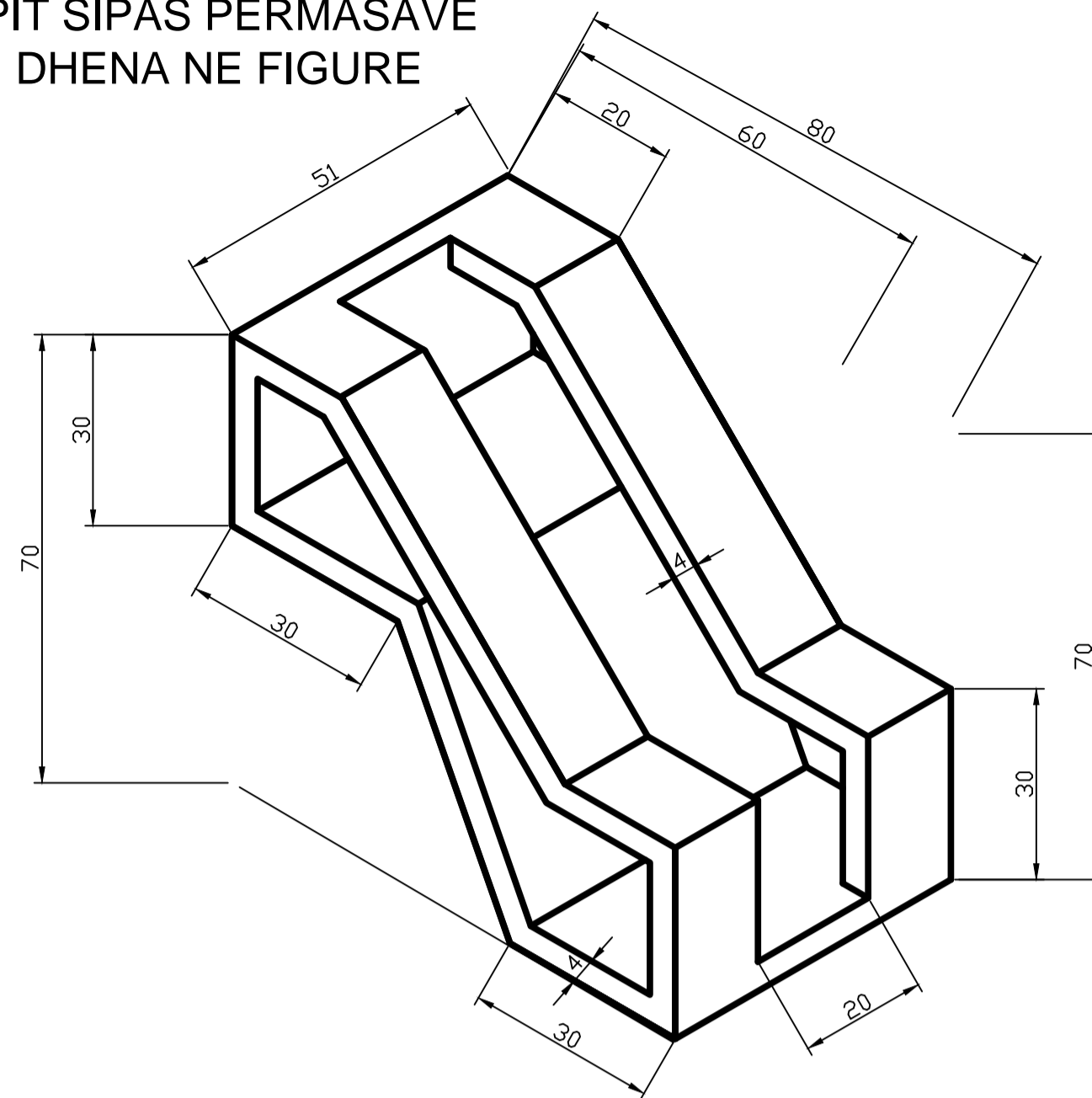

TE NDERTOHEH PROJEKSIONET E PIKAVE TE PRERJES SE DREJTEZES AB ME KONIN OCDFE DUKE JU REFERUAR FIGURES SE DHENE

5

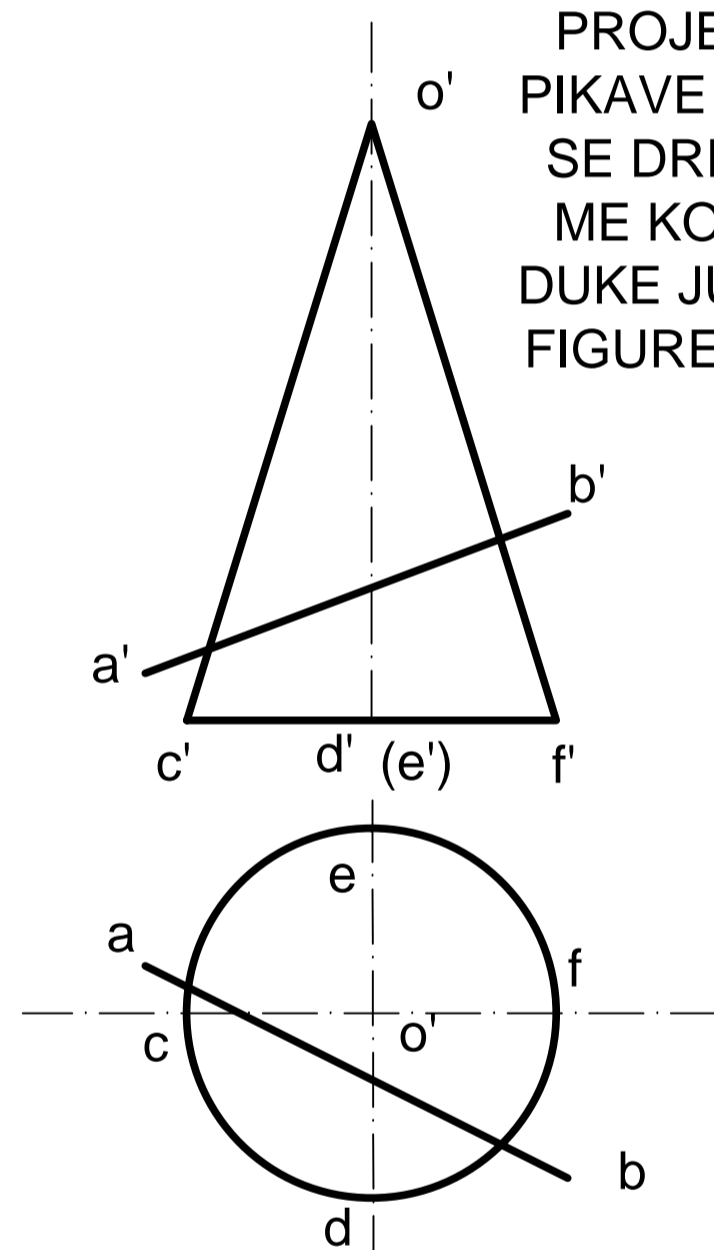

9

TE NDERTOHEH PROJEKSIONET E PIRAMIDES ME BAZE KATROR ME BRINJE 50MM, ME BAZE NE PLANIN HORIZONTAL TE PROJEKTIMIT E CPUAR NGA NJE CILINDER ME DIAMETER 20 MM. AKSI I CILINDRIT DHE PIRAMIDES JANE TE PERPTHUTA

3

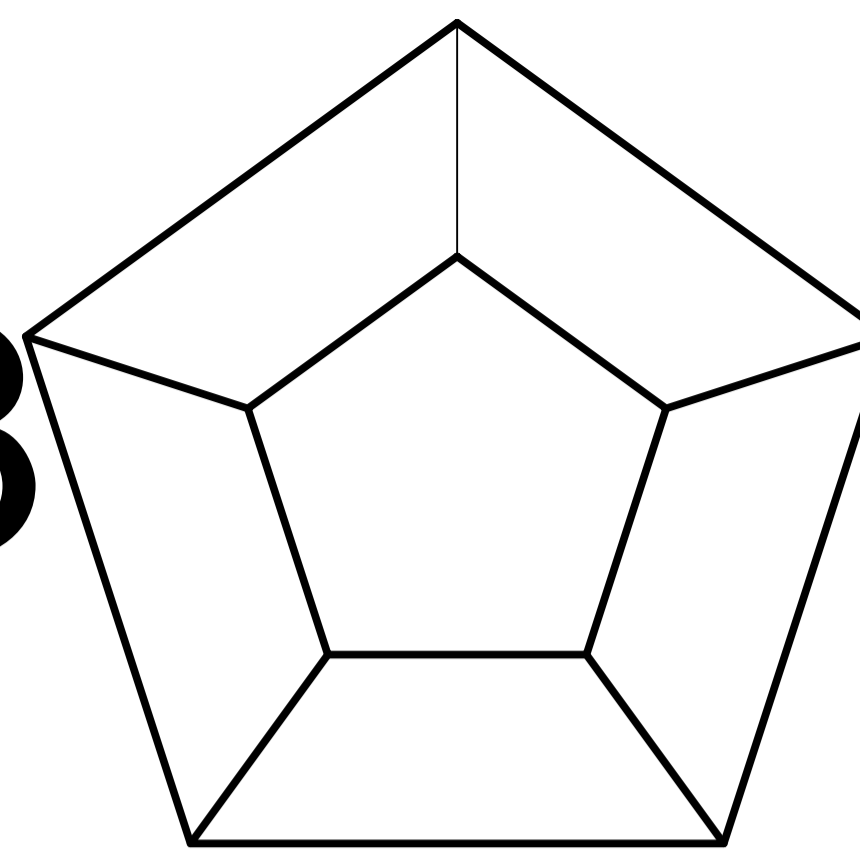

TE NDERTOHEH PROJEKSIONI ANESOR

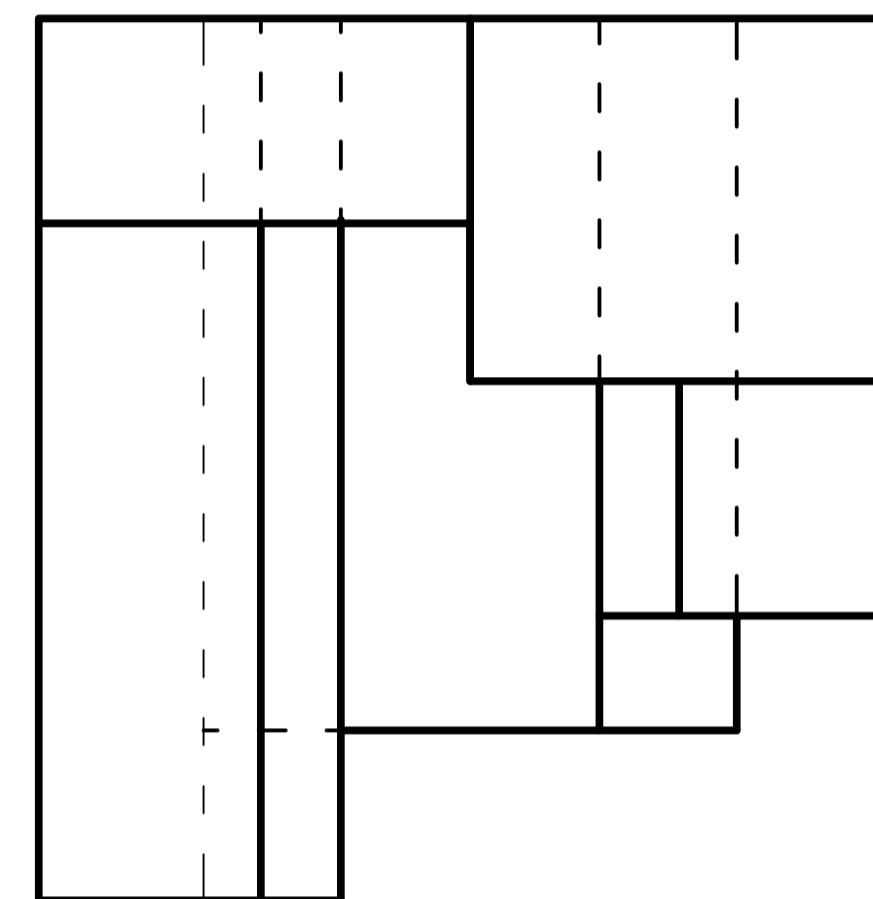

6

TE NDERTOHEH AKSONOMETRIA IZOMETRIKE E CILINDRIT ME DIAMETER 30 MM DHE LARTESI 45MM

10

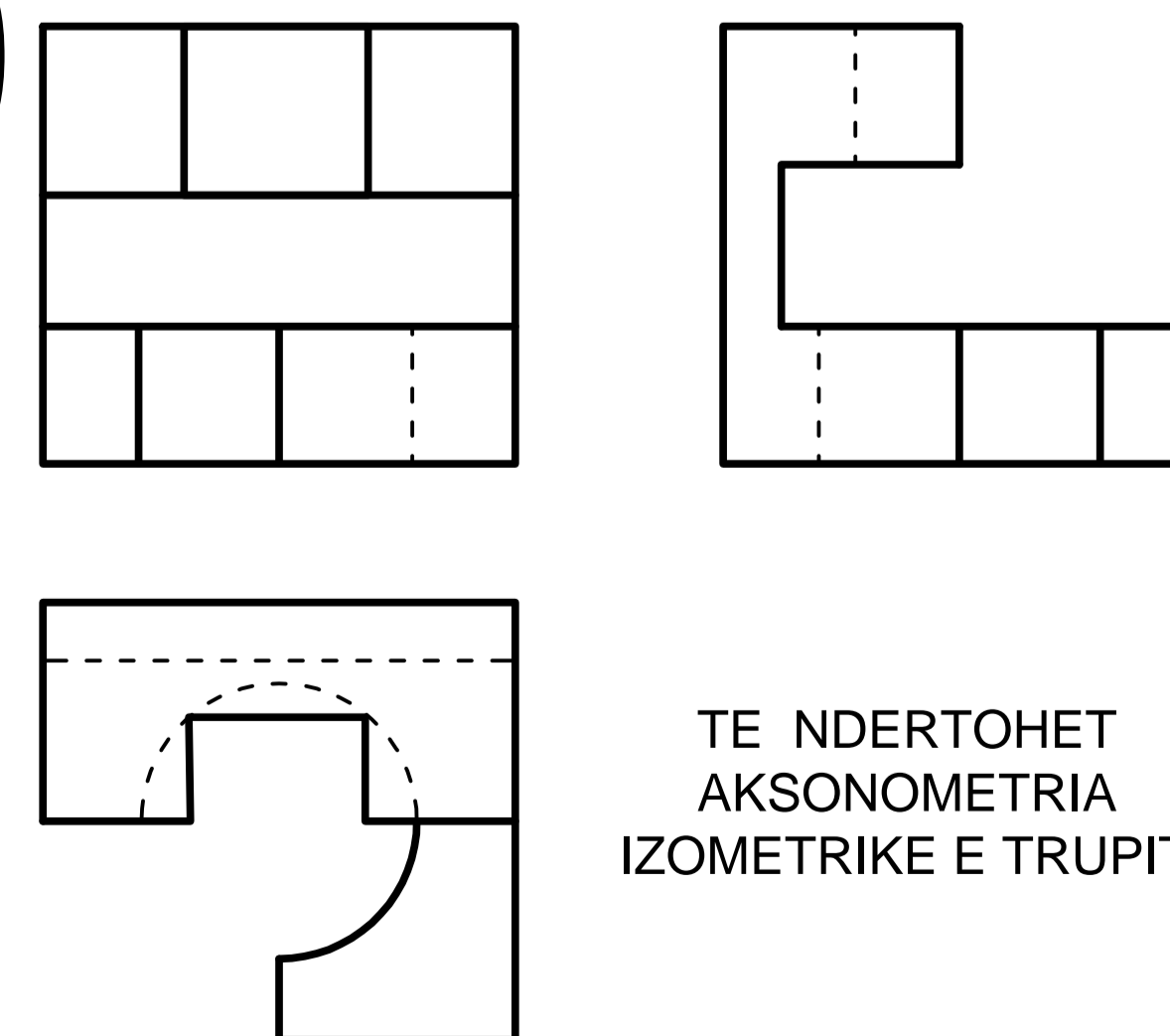

TE NDERTOHEH AKSONOMETRIA IZOMETRIKE E TRUPIT

4

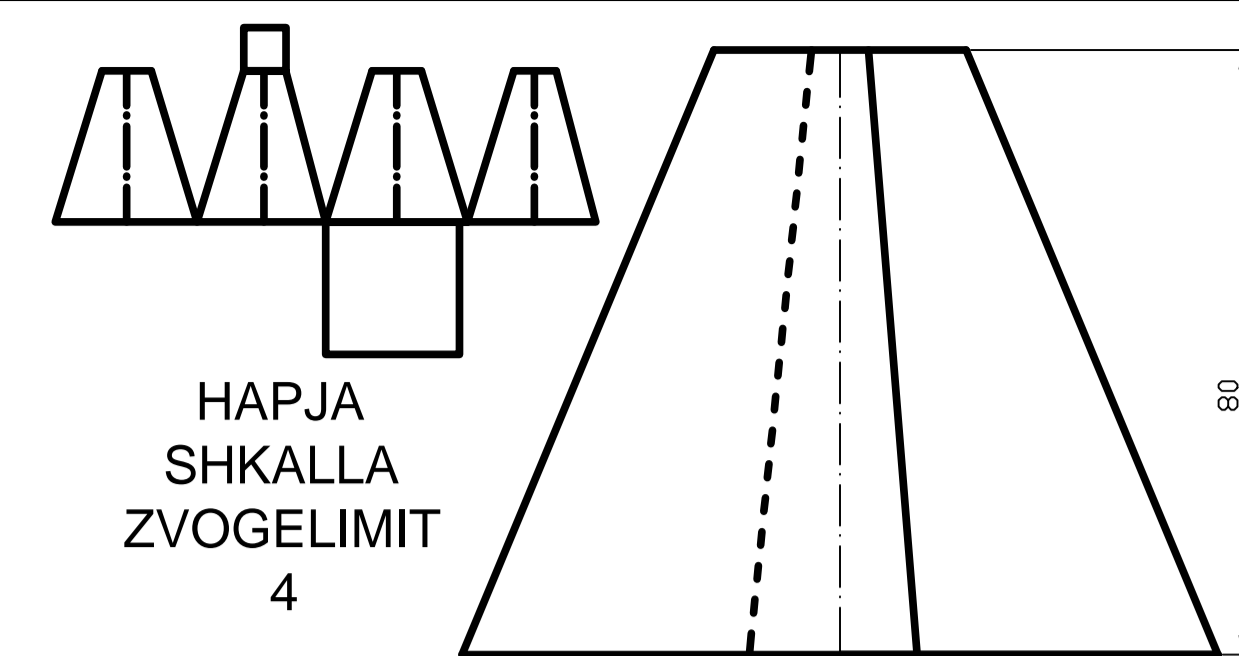

TE REALIZOHET HAPJA E TRUNGUT TE PIRAMIDES SIPAS PERMASAVE TE DHENA NE FIGURE

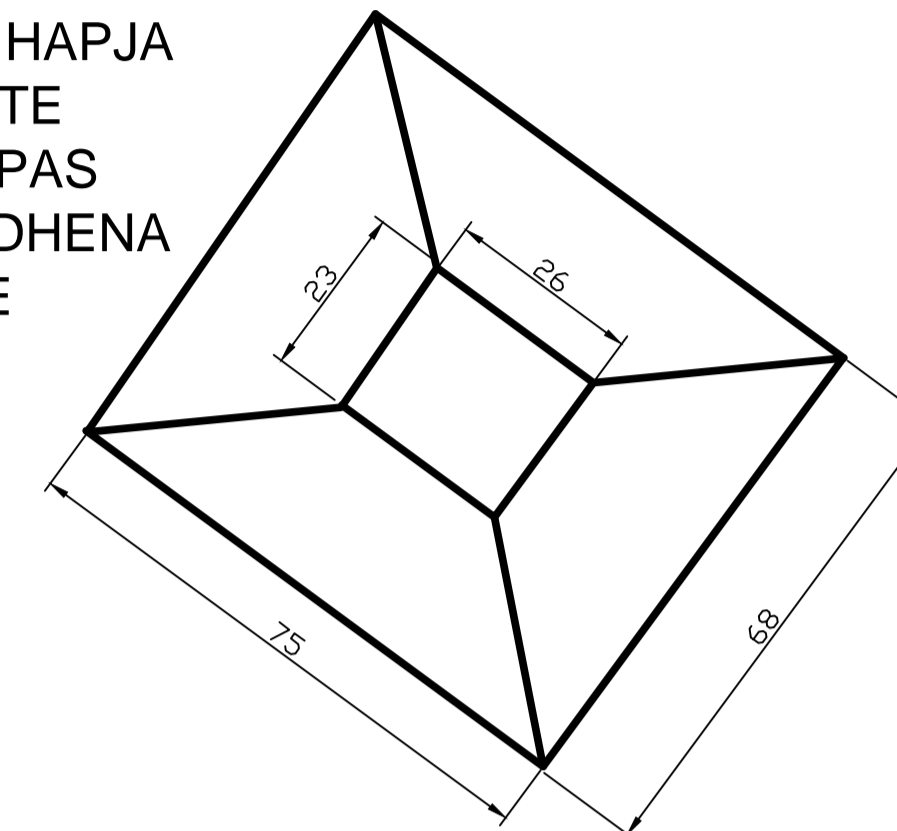

TE REALIZOHET PRERJA E KONIT ME CILINDRIT SIPAS PERMASAVE TE DHENA

7

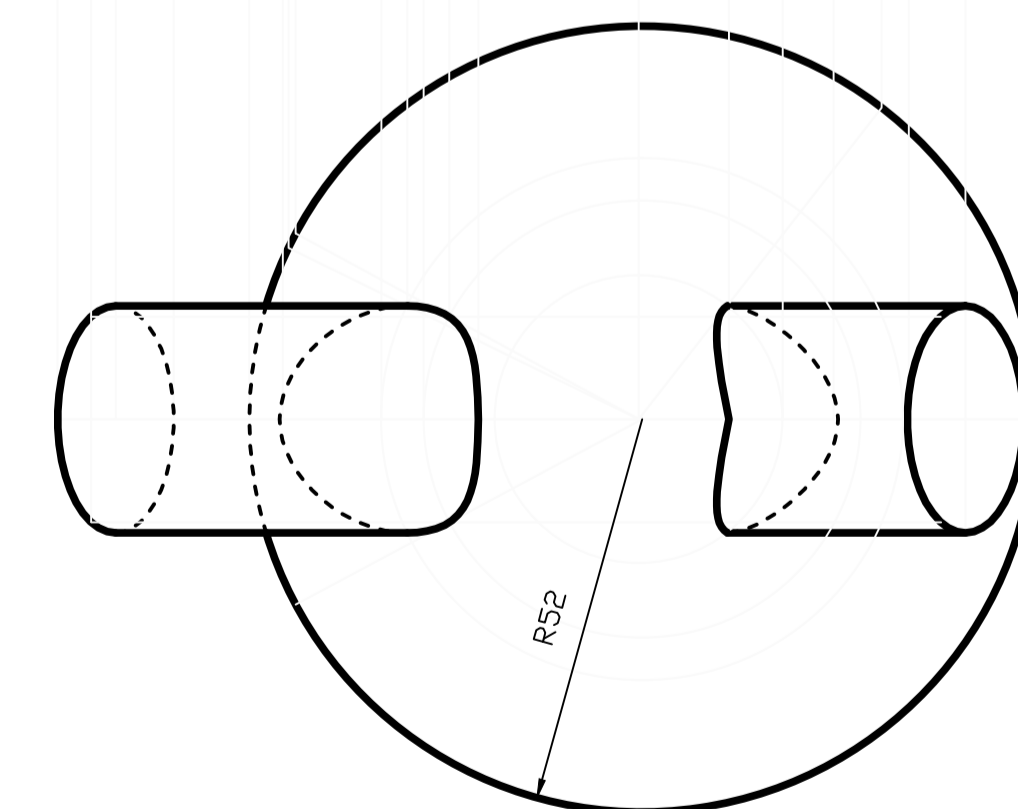
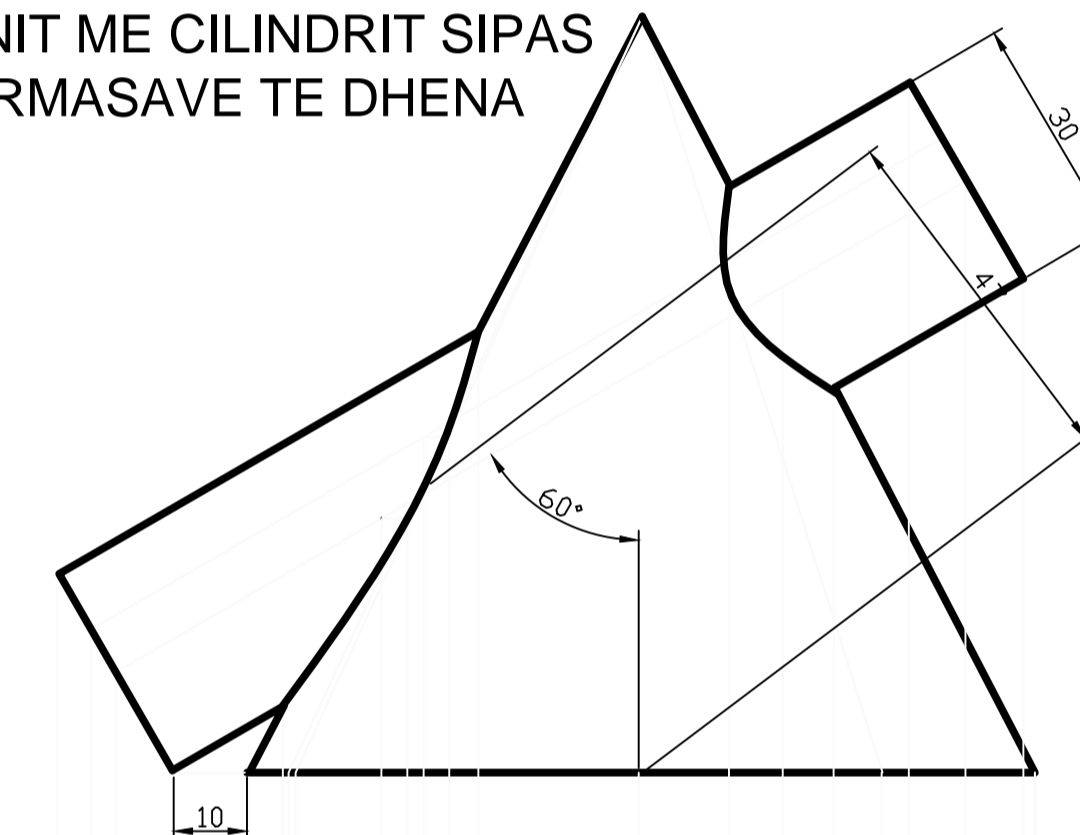

stampo njelloj si varianti A